

## User Guide

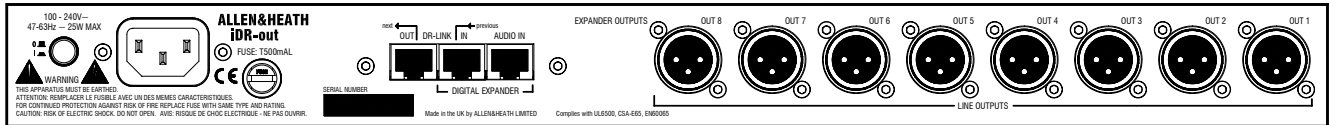
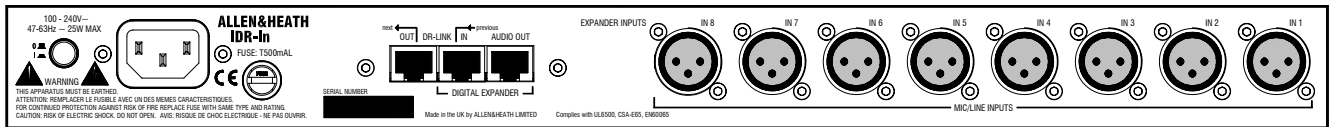
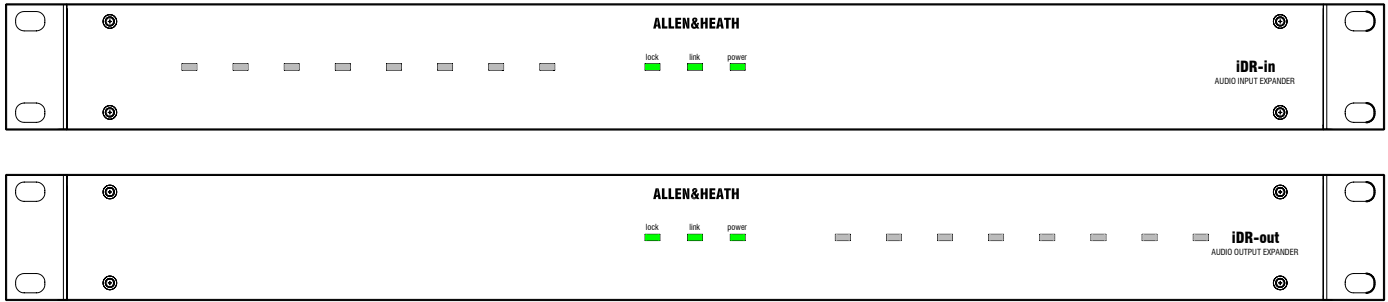

**iDR-in** and **iDR-out** are add-on audio expander units for the Allen & Heath **iDR-4** and **iDR-8** audio mix processors. They provide additional analogue audio inputs and outputs to add to those on the main unit. The **iDR-in** has 8 mic/line inputs, the **iDR-out** has 8 line outputs. One or both may be connected to the **iDR**. Only one of each may be added to the **iDR** system bringing it up to a maximum 16x16 audio matrix. These units do not have any processing built in. They simply convert between analogue and digital audio to work with an 8 channel wide digital bus which feeds the main unit via a CAT5 STP cable. The **iDR-in** features high grade mic/line preamps with PC configured gain, pad and phantom power switching, and a built-in soft clip limiter. The **iDR-out** provides electronically balanced differential outputs. The processing is available on the main **iDR-4** or **iDR-8** unit which features the full 16x16 DSP matrix. Both units have 8 front panel LEDs in addition to the 3 status indicators. These are 3-colour soft LEDs which can be assigned as audio meters, mute indicators or patch related indicators. They are programmed in the usual way using the **iDR** System Manager software. Control of the expanders is via the DR-Link port using a CAT5 STP cable. This means that two CAT5 cables are required to interconnect an expander to the main unit. Maximum distance between the units is 250 metres. Local mains power is required.

**CE** This product complies with the European Electromagnetic Compatibility directives 89/336/EEC & 92/31/EEC and the European Low Voltage Directives 73/23/EEC & 93/68/EEC.

**NOTE:** Do not remove the cover of the unit. There are no user serviceable parts inside. Any changes or modifications to the equipment not approved by Allen & Heath could void the compliance of the equipment and therefore the users authority to operate it.

### iDR-in/out User Guide AP4774 Issue 2

Copyright © 2003 Allen & Heath Limited. All rights reserved

Whilst we believe the information in this guide to be reliable we do not assume responsibility for inaccuracies. We also reserve the right to make changes in the interest of further product development.

The **iDR-in** and **iDR-out** expanders can be rack mounted or free standing. There are no user controls on the front panel, only the status and assignable LEDs. Allow a minimum of 75mm clearance behind the unit for the connectors and cables. Ensure adequate ventilation to the side of and behind the unit.

It is shipped with its rack ears fitted and its feet removed ready to be mounted in a standard 19" equipment rack. 1U rack space is required. For desk mount operation remove the two rack ears using a Torx (star head) T10 screwdriver. Fit the four plastic feet provided by pressing them into the underside.

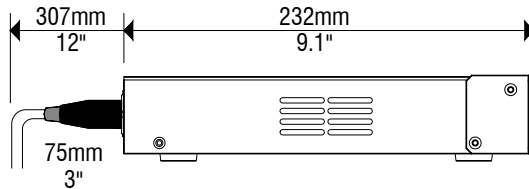
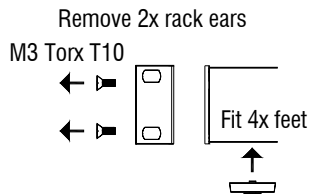
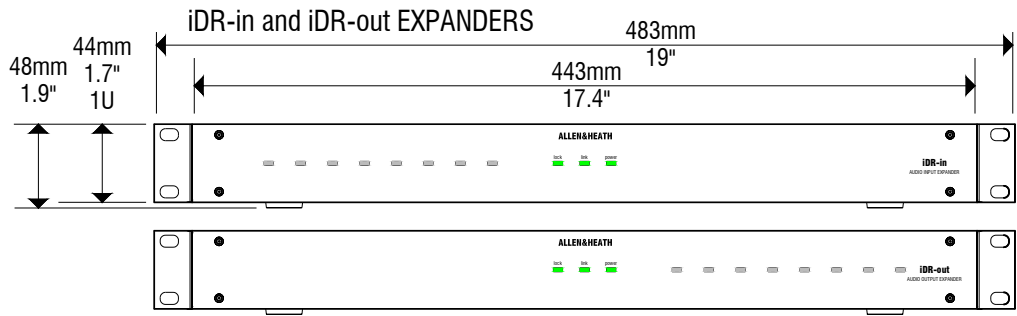

100 - 240V~  
47-63Hz ~ 25W MAX

**ALLEN&HEATH**  
**iDR-in**

FUSE: T500mAL

**WARNING**  
THIS APPARATUS MUST BE EARTHED.  
ATTENTION: REMPLACER LE FUSIBLE AVEC UN DES MEMES CARACTERISTIQUES.  
FOR CONTINUED PROTECTION AGAINST RISK OF FIRE REPLACE FUSE WITH SAME TYPE AND RATING.  
CAUTION: RISK OF ELECTRIC SHOCK. DO NOT OPEN. AVIS: RISQUE DE CHOC ELECTRIQUE - NE PAS OUVRIR.

**▲ Make sure you have read the Important Safety Instructions printed earlier. Also check that your local mains supply is compatible with that printed on the rear panel of the unit. Ensure that the correct mains lead with moulded plug and IEC connector has been supplied. For your own safety and optimum performance make sure the system is correctly grounded.**

**▲ To avoid any unexpected audible clicks or thumps always turn connected power amplifiers down or off before switching the iDR or any other signal equipment on or off.**

lock link power

**Turning the expander on or off** First make sure the unit is correctly plugged up and connected to the **iDR-4(8)**. This is described below. Turn the unit on by pressing the rear panel power ON/OFF switch. The power LED lights up. The link LED lights if the DR-Link connection is established with the **iDR-4(8)**. The lock LED lights once the link is established and audio is correctly communicated with the **iDR-4(8)**. The iDR System Manager detects the presence of the expander.

If one or more of the LEDs do not light then check that the cables are correctly fitted and the **iDR-4(8)** is functioning normally.

**\*8 Diagnostics**  
**Audio Exp:In/Out**

**Checking for expanders** You can use the front panel **iDR-4(8)** Setup menus to check if any expanders are connected and recognised. This is useful when the expanders are located far away from the main unit. With the face plate removed access menu \*8 Diagnostics and scroll to Audio Exp. Refer to the **iDR-4** user guide AP5230 or **iDR-8** user guide AP4530 for further details.

**CONNECTING THE INPUT EXPANDER**

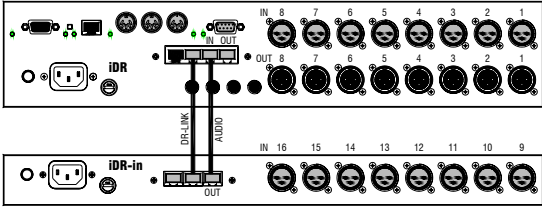

**CONNECTING THE OUTPUT EXPANDER**

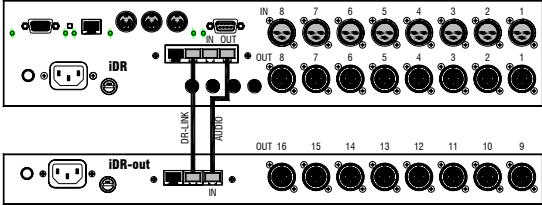

**CONNECTING BOTH EXPANDERS**

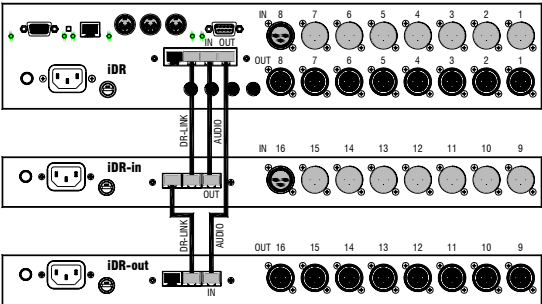

**Connecting to the iDR-4(8)** You can connect either or both expanders according to the requirements of your application. The **iDR-in** AUDIO OUT connects to the **iDR-4(8)** AUDIO IN. The **iDR-out** AUDIO IN connects to the **iDR-4(8)** AUDIO OUT. Ensure that the expander DR-Link IN connects to DR-Link on the **iDR-4(8)** it is associated with. If both expanders are used with the same **iDR-4(8)** then daisy chain from DR-Link OUT on one to DR-Link IN on the other. DR-Link can also be daisy chained from or to **iDR-switch** units if you are using them as well.

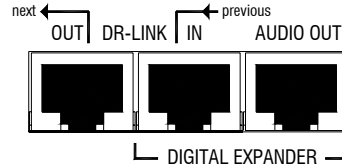

**Fully expanded iDR-4(8)** The diagram below shows the **iDR-8** with both the input and output expanders fitted. Note the connection of DR-Link which is daisy chained from one unit to the next. If an **iDR-switch** unit is also fitted then daisy chain DR-Link from the last expander to the switch box. Make sure you plug into the correct DR-Link socket.

Use CAT5 STP cable. A pair of standard 2 metre cables is provided with each expander. Maximum cable length is 250 metres. This means that the expander units can be used for remote audio over CAT5 cable.

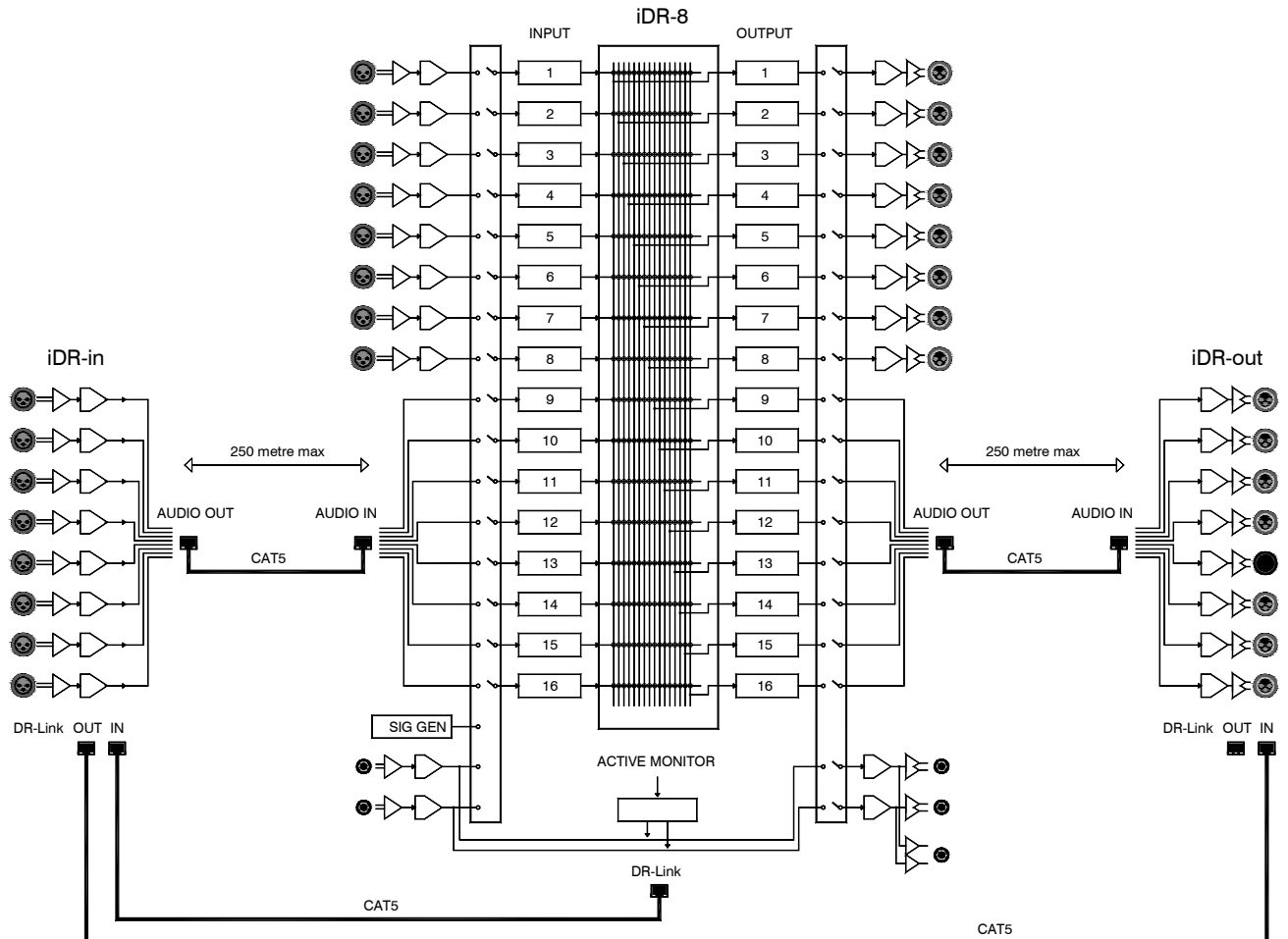

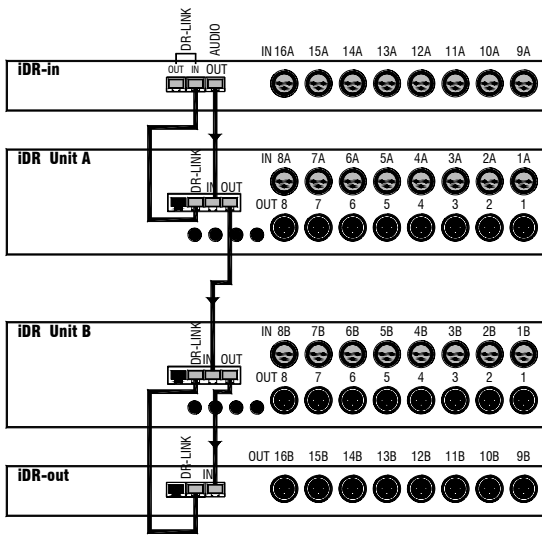

**Expanded multiple iDR system** This diagram shows an iDR system with two iDR-8 units and both expanders fitted. A system could also be created with iDR-4 units or a mix of iDR4 and iDR-8 units. DR-Link is only required to connect to the expanders, not between the main units. Make sure you connect DR-Link to the iDR associated with each expander. Make sure you plug into the correct DR-Link socket. In this case do not daisy chain DR-Link from one expander to the other.

Use CAT5 STP cable. Maximum cable length is 250 metres. Maximum audio matrix is 16x16. The audio link cable carries 8 channels. This can provide a distributed system with 8 common channels and 8 local channels at each unit.

### Mic/Line Inputs x8

- Female 3pin XLR
- Electronically balanced, pin 2 hot
- Impedance 2k (pad out), >10k ohm (pad in)
- Sensitivity -50dBu to +5dBu
- Gain range -15 to +50dB in 3dB steps
- Pad -20dB
- Sensitivity (pad out) -50 to -5dBu
- Sensitivity (pad in) -30 to +15dBu
- Maximum input level +33dBu
- Pre converter soft limiter -4dBFS, switchable
- Phantom power +48V DC switched

### Line Outputs x8

- Male 3pin XLR
- Electronically balanced, pin 2 hot
- Impedance <75 ohms
- Maximum output +18dBu

### Expander Input / Output Port

- RJ45 connector
- Proprietary 8 channel digital audio
- Connects to iDR-4 or iDR-8 main unit
- CAT5 STP cable up to 250 metres (825 feet)

### Converters

- 24bit resolution
- A/D dynamic range 109dB A-weighted
- 106dB unweighted
- D/A dynamic range 115dB A-weighted
- 112dB unweighted

### DR-Link Port

- Serial control of iDR expander units
- Proprietary Allen & Heath control protocol
- RJ45 connector
- IN and OUT ports provided to allow daisy chaining through multiple units
- CAT5 STP cable up to 300 metres (1000 feet)

### Performance

- Frequency response 20Hz-20kHz +0/-0.5dB
- Crosstalk <-80dB @ 1kHz, 0dB gain
- THD+noise <0.01% @ 1kHz, 0dBu
- Residual output noise <-93dBu
- Input to output noise @ 0dB gain <-87dBu
- Input to output noise @ 50dB gain <-73dBu
- Latency <2.4ms expander XLR to/from iDR XLR
- This is <0.084ms additional to iDR

### Status LEDs

- Power –mains power on
- Link – iDR-Link control communicating
- Lock –audio communicating

### Soft LEDs

- Assignable by the installer
- iDR-in 8x front panel
- iDR-out 8x front panel
- 3-colour – green, yellow, red, off
- Function 3-colour signal meters
- Mute on/off
- Static patch related

### Power Supply

- Universal mains input switched mode design
- IEC 3pin
- Country dependent mains lead supplied
- Rear panel power on/off switch
- AC mains input 100-240V AC 50/60Hz
- 25VA max
- Fuse T500mA 20mm

### Mechanical

- 1U rack 483 x 232 x 44mm
- 19" x 9.1" x 1.7"
- Desk 443 x 232 x 48mm
- 17.4" x 9.1" 1.9"
- Weight 3.5kg, 7.7lbs

